

客 戶

CUSTOMER: \_\_\_\_\_

## 送 樣 承 認 書

### Crystal Resonator datasheet

產 品 名 稱

DESCRIPTION: Quartz Crystal Resonator MC-306

產 品 型 號 / 料 號

PART NO: 32.768KHz /BD-MC-306

客 戶 料 號

Client NO: \_\_\_\_\_

送 樣 日 期

DATE: 2023-2-23

供應商審核 Confirmed By Ourselves			客戶確認 Client Confirmed		
品質 Quality	研發 R/D	公章 Cachet	測試	審核	核准
劉媛	杜紅光				



BD CRYSTAL

供應商: 深圳市北迪榮昌電子有限公司

MANUFACTUREN: SHENZHEN BDRC ELECTRONICS CO., LTD

公司地址: 深圳市寶安區石岩街道園嶺石環路 118 號新永豐第二工業區 1 棟六樓

ADD: Floor 6, building 1, Xinyongfeng No.2 Industrial Zone, No.118,

Yuanling Stone Ring Road, Shiyan street, Bao'an District, Shenzhen

TEL: +86-0755-86212103 FAX: +86-0755-86212112

手機: 13480903123 李火星

<http://www.bdrcdz.com> Email: XABDRC@163.com

<b>深圳市北迪荣昌电子有限公司</b> <b>SHENZHEN BDRC ELECTRIC CO., LTD</b>	北 迪 P/N	BD-MC-306	
MC-306 石英晶体谐振器 Specification of quartz crystal	客 户 P/N		
	VER	01	PAGE 2/7

## 目 录

### CONTENT

规格	页次
SPECIFICATIONS	PAGE
1.技术参数	3
ELECTRICA SPECIFICATIONS	
2.机械特性	4
MECHANICAL CHARACTERISTICS	
3.印刷	5
MARKING	
4.外型尺寸	6
OUTLINE AND DIMENSION	
5.内部结构	7
BYELAW	

深圳市北迪荣昌电子有限公司 SHENZHEN BDRG ELECTRIC CO., LTD	北 迪 P/N	BD-MC-306	
MC-306 石英晶体谐振器 Specification of quartz crystal	客 户 P/N		
	VER	01	PAGE 3/7

## 1. 技术参数 ELECTRICAL SPECIFICATIONS

1	标称频率 Nominal frequency	32.768KHz
2	振荡模式 Mode of vibration	AT Fundamental
3	负载电容 Load capacitance	10.0pF
4	调整频差 Frequency tolerance	±20ppm(25±5°C)
5	温度频差 Frequency temperature characteristics	-0.034±0.006ppm/°C <sup>2</sup> (-40to+85°C)
6	谐振电阻 Equivalent series resistance	50K Ω max
7	静 电 容 Shunt capacitance	0.8pF Typ
8	绝缘电阻 Insulation resistance	500MΩmin./100±15VDC
10	激励电平 Drive level	0.1mW
11	老 化 率 Aging	±5ppm/year
12	贮存温度 Storage temperature range	-55°C to +125°C
13	测试仪器 Test Impedance Meter	S&A 250B

深圳市北迪荣昌电子有限公司 SHENZHEN BDRG ELECTRIC CO., LTD		北 迪 P/N		BD-MC-306	
MC-306 石英晶体谐振器 Specification of quartz crystal		客 户 P/N			
		VER	01	PAGE	4/7

## 2.机械特性 MECHANICAL CHARACTERISTICS

NO	测试项目 Test item	测试方法 Test Method	
1	跌落 Shock	100g dummy, Natural drop from 1500mm height on to the concrete, 3 directions * 10 times	$*3\Delta f/f:\pm 8\times 10^{-6}$
2	振 动 Vibration	频率 Frequency: 10-55Hz 峰值 Amplitude : 0.75mm 周期 Cycle time : 15 min (10-500-10 Hz) 方向 Direction : 3 mutually perpendicular planes in each 2h	$*3\Delta f/f:\pm 3\times 10^{-6}$
3	耐焊接热 Soldering	For convention reflow soldering furnace(2 times).	$*3\Delta f/f:\pm 5\times 10^{-6}$
4	高温储存 High temperature storage	温度 Temperature : $+125^{\circ}\text{C} \pm 5^{\circ}\text{C}$ 时间 Time : 1000 h $\pm 12$ h	$*3\Delta f/f:\pm 10\times 10^{-6}$
		温度 Temperature : $+85^{\circ}\text{C} \pm 5^{\circ}\text{C}$ 时间 Time : 1000 h $\pm 12$ h	$*3\Delta f/f:\pm 7\times 10^{-6}$
5	低温储存 Low temperature storage	温度 Temperature : $-55 \pm 5^{\circ}\text{C}$ 时间 Time : 1000 h $\pm 12$ h	$*3\Delta f/f:\pm 10\times 10^{-6}$
6	稳态湿热 High temperature and humidity	温度 Temperature : $+85 \pm 2^{\circ}\text{C}$ 湿度 Humidity : 85% RH 时间 Time : 1000 h	$*3\Delta f/f:\pm 10\times 10^{-6}$
7	温度循环 Temperature cycle	$-55^{\circ}\text{C} \leftrightarrow +125^{\circ}\text{C}$ 30 minutes at each temperature *100 cycles	$*3\Delta f/f:\pm 10\times 10^{-6}$
8	回流焊 Reflow		$*3\Delta f/f:\pm 10\times 10^{-6}$

深圳市北迪荣昌电子有限公司 SHENZHEN BDRG ELECTRIC CO., LTD	北 迪 P/N	BD-MC-306	
MC-306 石英晶体谐振器 Specification of quartz crystal	客 户 P/N		
	VER	01	PAGE 5/7

### 3. 印刷 Marking

Marking

深圳市北迪荣昌电子有限公司 SHENZHEN BDRG ELECTRIC CO., LTD	北 迪 P/N	BD-MC-306	
MC-306 石英晶体谐振器 Specification of quartz crystal	客 户 P/N		
	VER	01	PAGE

#### 4. 外型尺寸 OUTLINE (Unit : mm)

##### ● MC-306

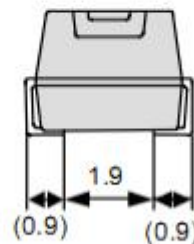
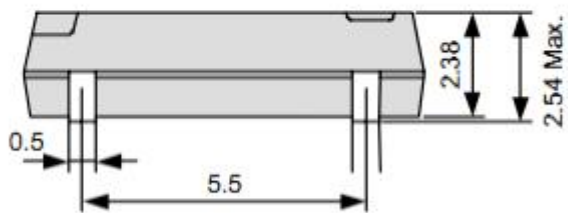
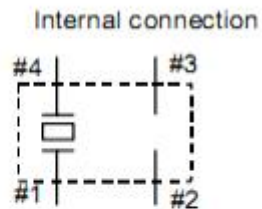
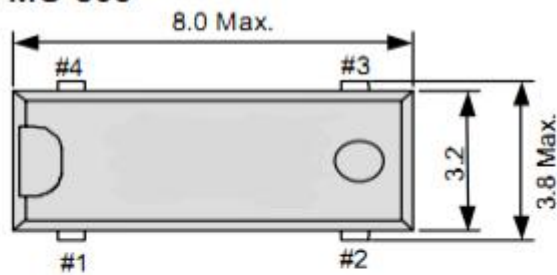

Do not connect #2 and #3 to external device.  
 Metal may be exposed on the top or bottom of this product.  
 This will not affect any quality, reliability or electrical spec.

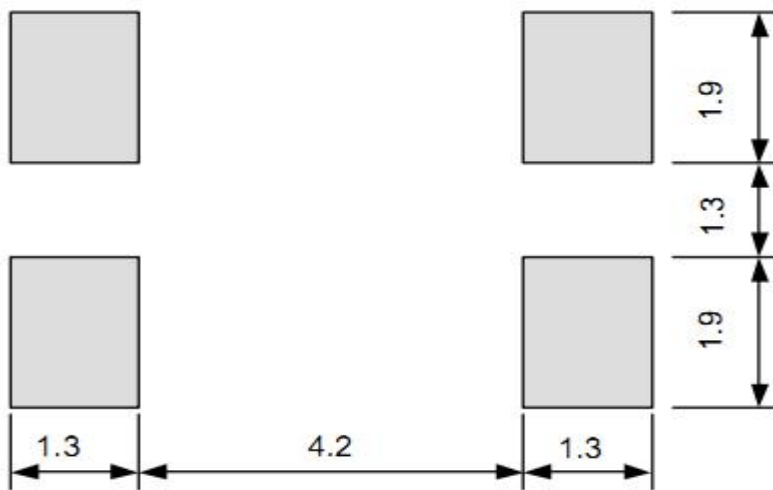

深圳市北迪荣昌电子有限公司 SHENZHEN BDRC ELECTRIC CO., LTD	北 迪 P/N	BD-MC-306	
MC-306 石英晶体谐振器 Specification of quartz crystal	客 户 P/N		
	VER	01	PAGE 7/7

### 5. 内部结构 BYELAW

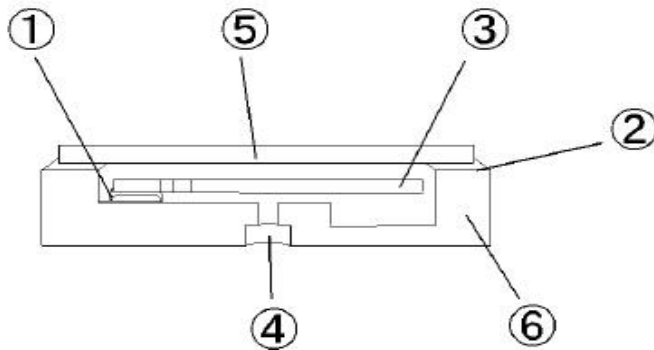
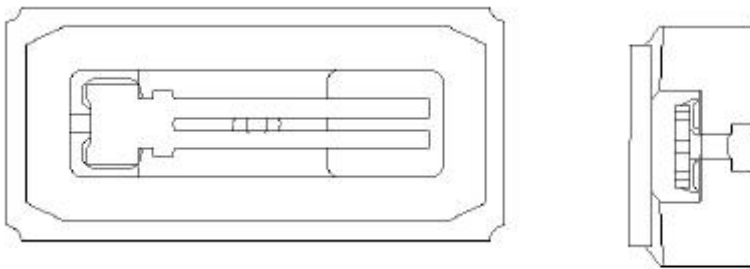

LIST		
	Name of part	Material
①	Crystal Adhesive	Ag Paste
②	Sealing	Seal Glass
③	Chip	Crystal
④	Sealing	Au/Ge
⑤	Lid	Glass
⑥	Package	Ceramic (Al <sub>2</sub> O <sub>3</sub> )